

PN532 NFC RFID Module User Guide

Version 3

Introduction



NFC is a popular technology in recent years. We often heard this word while smart phone company such as Samsung or HTC introduces their latest high-end phones. Almost all the high-end phones in the market support NFC.

[Near field communication \(NFC\)](#) is a set of standards for smartphones and similar devices to establish radio communication with each other by touching them together or bringing them into close proximity, usually no more than a few centimeters.

For electronics geeks, we also want to use NFC technology to make our own things. So we build this NFC RFID module. This module is built around NXP PN532. NXP PN532 is very popular in NFC area. And the company offers much technology document to help developers. We developed this module based on the official document. To make things easier, we also build library for this module.

We almost break out all the IO pins of NXP532 on this module. Users could easily connect and play. With our [Arduino Sensor Shield](#), it is very easy to plug and play. However, if users want to use other interface such as UART or SPI, this module also makes it easy to connect those pins.

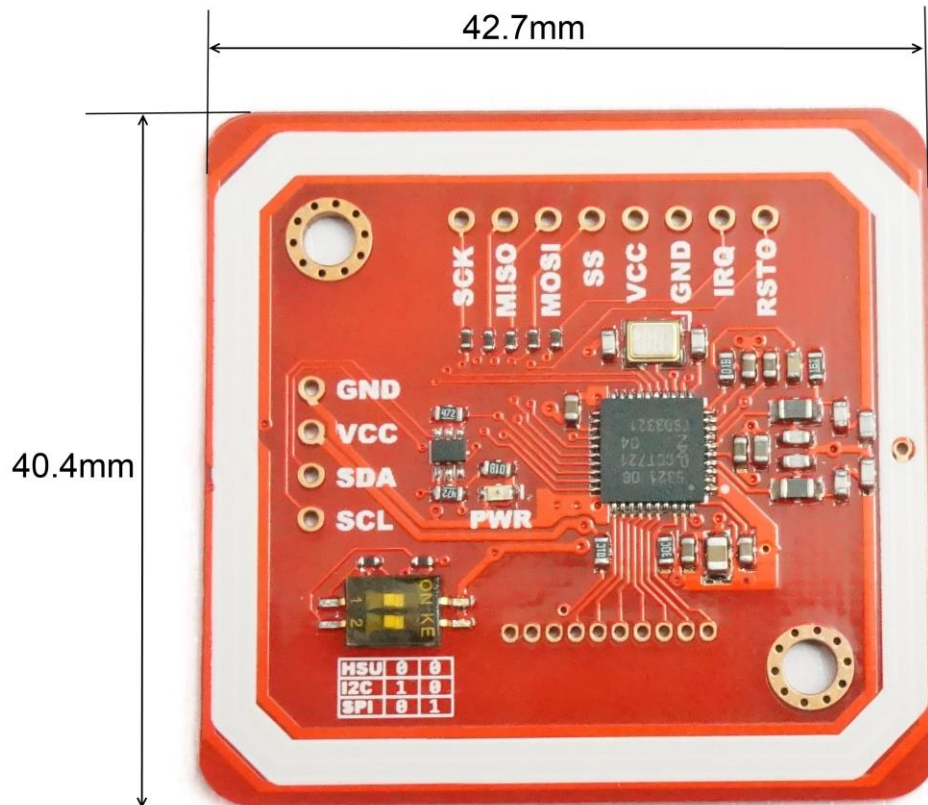

We have updated this module to version 3. Compared with V2, V3 have the following improvement:

1. **Smaller:** the size now is as small as 42.7mm*40.4mm*4mm
2. **Easy to change mode:** with a small SMD toggle Switch, it becomes very easy to change among IIC, SPI and HSU modes
3. **Longer distance:** the reading distance becomes 5~7cm, compared with 4~6 cm of last version
4. **Add software to support NFC with Android Phone**

Features

1. Support IIC, SPI and HSU (High Speed UART)
2. RFID reader/writer mode support
 - Mifare 1k, 4k, Ultralight, and DesFire cards
 - ISO/IEC 14443-4 cards such as CD97BX, CD light, DesFire, P5CN072 (SMX)
 - Innovision Jewel cards such as IRT5001 card
 - FeliCa cards such as RCS_860 and RCS_854
3. Plug and play, Arduino compatible
4. Built in PCB Antenna, with 5cm~7cm communication distance
5. On-board level shifter, Standard 5V TTL for I2C and UART, 3.3V TTL SPI
6. Work as RFID reader/writer
7. Work as 1443-A card or a virtual card
8. Support NFC with Android phone
9. Small size: 43mm*41mm*4mm

Interface

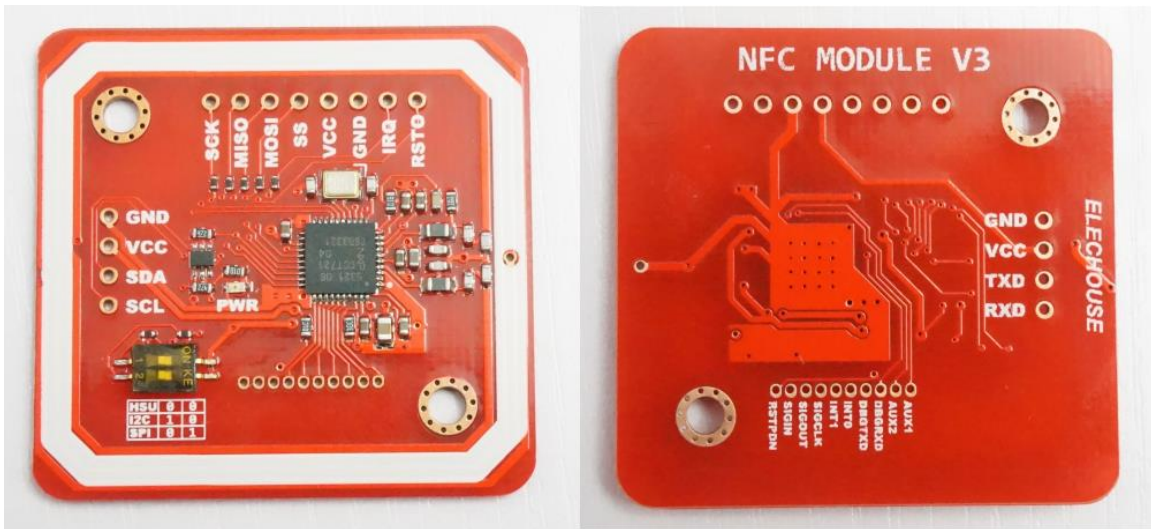

- VCC: 3.3V~5V
- I2C/UART: 3.3V~24V TTL
- SPI: 3.3V TTL with 100 ohm resistors in series. It could be connected directly to 5V interface of microcontroller such as Arduino.

The I2C and HSU shares the same pins. The definition of IIC pins is printed at front and the HSU's is printed at the back. The HSU mode is configured as the default mode. But you could change the interface by setting the toggle switch.

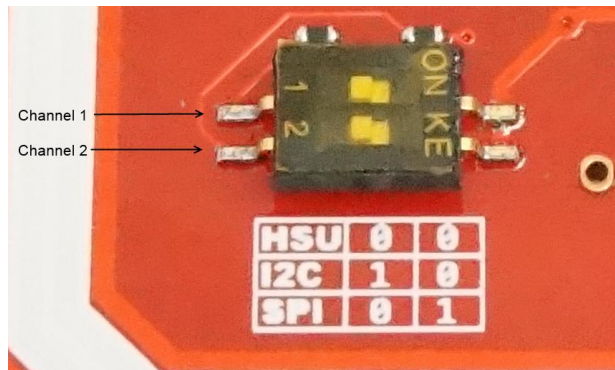

The switch setting is shown as follows:

Working Interface	Channel	Channel
	1	2
HSU	OFF	OFF
I2C	ON	OFF
SPI	OFF	ON

We break all the PN532 pins out. The 1.27mm connector hole contains those pins which might not be used for most users. If some developers need to connect those pins, we could supply connectors.

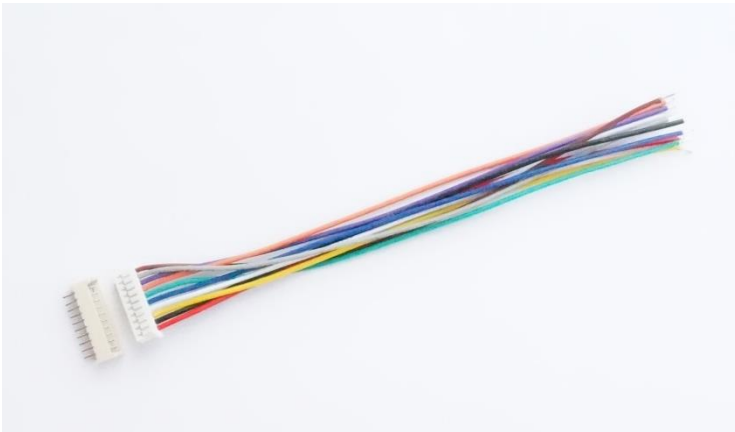

[You could find this product here.](#)

Hardware Installation

Solder the connector

The bended male pins come with the NFC board.

Some users might need soldering other types of connectors or directly solder wires on it. Anyway, make sure the wires go across the antenna lines in 90 degree.

Antenna is covered under the white paint

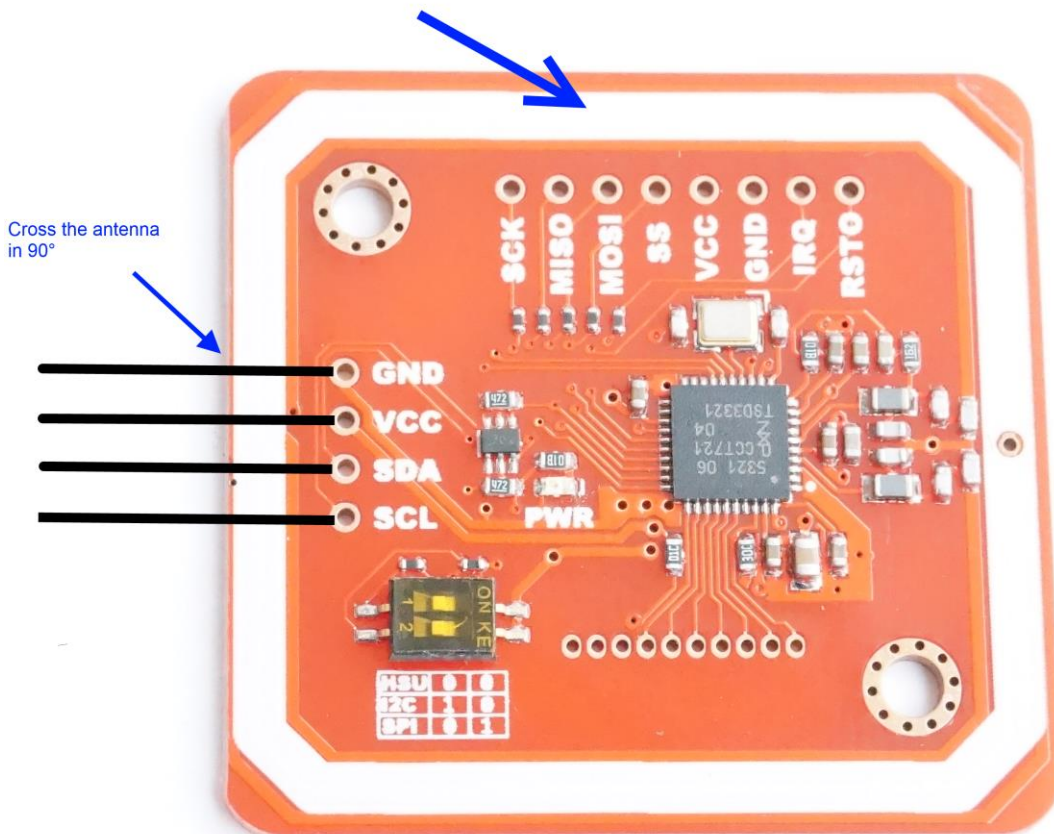

Connect with Arduino

If without the sensor shield, please connect as following:

Mode	PN532 Module	Arduino UNO	Arduino Leonardo	Arduino Mega (2560)	Arduino Due	
Power	VCC	5V	5V	5V	5V	
	GND	GND	GND	GND	GND	
IIC/I2C Mode	SDA	A4/SDA	Pin 2 /SDA	Pin 20 /SDA	Pin 20 /SDA	
	SCL	A5/SCL	Pin 3/SCL	Pin 21/SCL	Pin 21/SCL	
HSU Mode	TXD	Pin 0	Could not present message in Serial Monitor on PC	Pin 0	Pin 19	Pin 19
	RXD	Pin 1		Pin 1	Pin 18	Pin 18
SPI Mode	SCK	Pin 13 or ICSP-3	ICSP-3	Pin 52 or ICSP-3	ICSP-3	Note: SPI on Due is still in developing
	MISO	Pin 12 or ICSP-1	ICSP-1	Pin 50 or ICSP-1	ICSP-1	
	MOSI	Pin 11 or ICSP-4	ICSP-4	Pin 51 or ICSP-4	ICSP-4	
	SS	Pin 10	Pin 10	Pin 10	Pin 10	

Arduino UNO only has one serial interface which is also connected to USB port to PC. In HSU mode, the serial monitor could not be used as message displaying windows.

Function Test

RFID Reader/Writer

Here we show how to read and write RFID card with this module.

Download the library [PN532](#) at our github page. You could find 4 folders in the library. Unzip the 4 folders at the library folder in Arduino IDE.

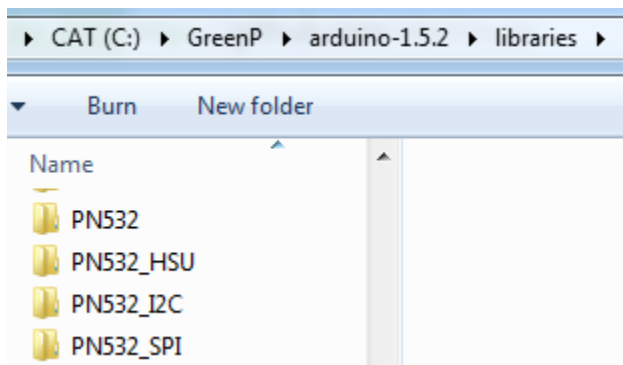

Start Arduino IDE and choose the example:

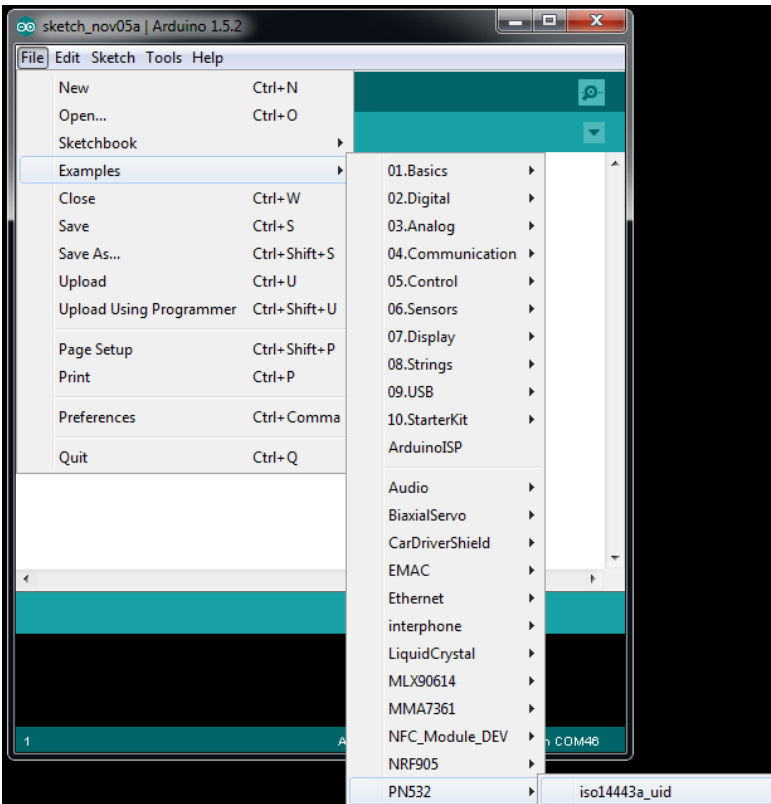

Modify the code to choose the right mode:

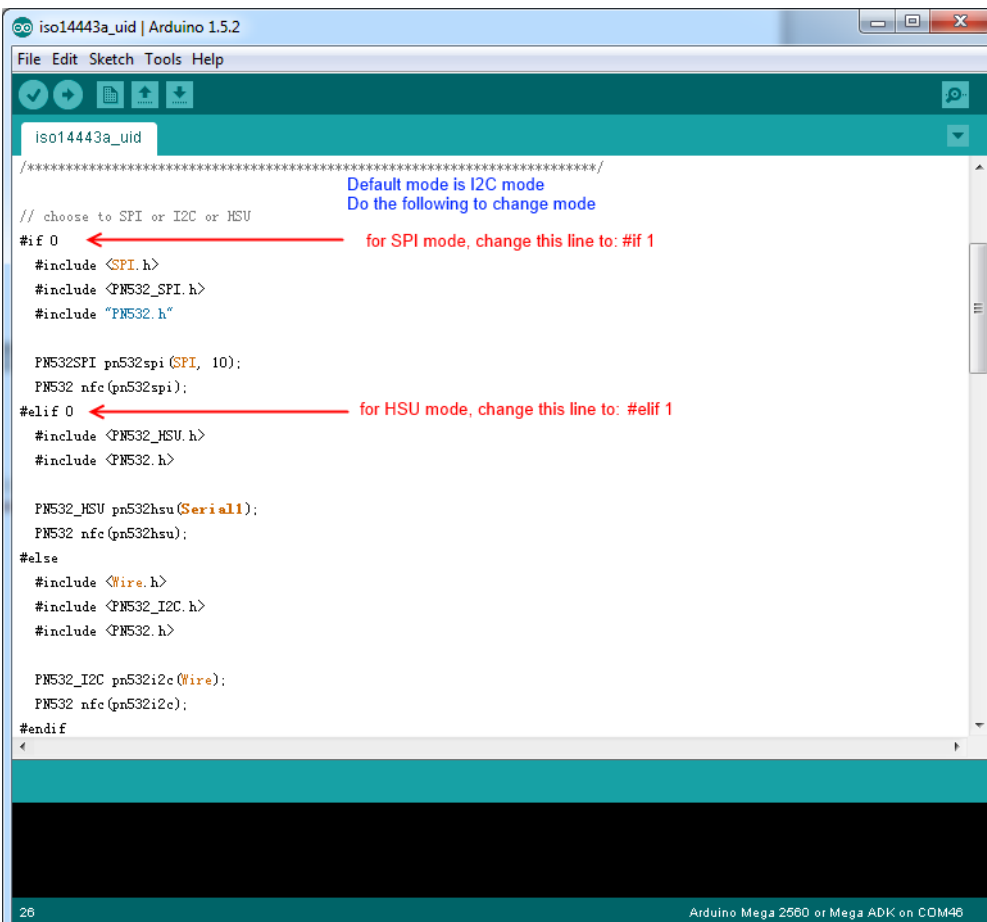

Upload the code to Arduino and open Serial monitor. Put a card on it:

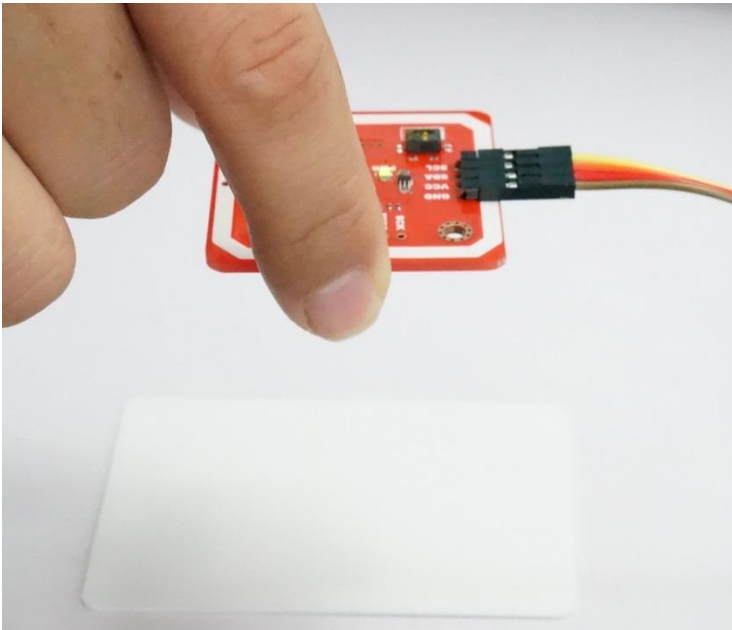

```
COM46
Hello!
Read Ack
00FF0FF0Read response
00FF6FA D5 3 32 1 6 7 E8 0Found chip PN532
Firmware ver. 1.6
Read Ack
00FF0FF0Read response
00FF2FE D5 33 F8 0SAMConfig
Read Ack
00FF0FF0Read response
00FF2FE D5 15 16 0Waiting for an ISO14443A card
Read Ack
00FF0FF0Read response
00FFCF4 D5 4B 1 1 0 4 8 4 9D 44 A3 46 4 0ATQA: 0x 4SAK: 0x 8
Found a card!
UID Length: 4 bytes
UID Value: 0x9D 0x44 0xA3 0x46
Read Ack
00FF0FF0Read response
00FFCF4 D5 4B 1 1 0 4 8 4 9D 44 A3 46 4 0ATQA: 0x 4SAK: 0x 8
Found a card!
UID Length: 4 bytes
UID Value: 0x9D 0x44 0xA3 0x46
Read Ack
00FF0FF0Read response
00FFCF4 D5 4B 1 1 0 4 8 4 9D 44 A3 46 4 0ATQA: 0x 4SAK: 0x 8
Found a card!
UID Length: 4 bytes
UID Value: 0x9D 0x44 0xA3 0x46
Read Ack
00FF0FF0Read response
00FFCF4 D5 4B 1 1 0 4 8 4 9D 44 A3 46 4 0ATQA: 0x 4SAK: 0x 8
Found a card!
```

You could also try other reading/writing example code in the library.



It also supports reading flexible tag. We tested flexible tags of Mifare 1 S50 and Ultralight. The reading distance is up to 5cm.

[You could find those flexible tags here.](#)

P2P NFC

Currently we are still developing the software. The P2P NFC communication between two PN532 modules is only supported by I2C mode. Please [download this library](#).

Note, while testing this library, please remove the libraries in the testing above (or other PN532 libraries) to other folders. Otherwise they might conflict.

Here we need two Arduino boards to test this function. Basically we will program one NFC module as Initiator, and the other as Target.

Please upload the following two examples to the two Arduino board:

- `NFC_p2p_initiator`
- `NFC_p2p_target`

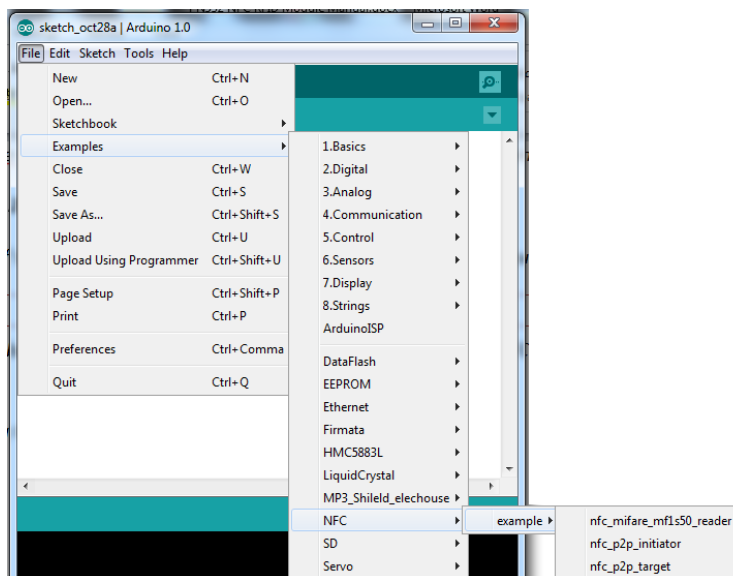

After uploading the sketches, open the Serial Monitor. Please note that Arduino IDE doesn't support opening 2 Serial Monitors. So you need another Serial Tool. Here we have 2 versions of Arduino IDE installed in my PC: Arduino 0022 and Arduino 1.0. We open the two and could have two Serial Monitor working. Note the baud rate is 115200.

Target:

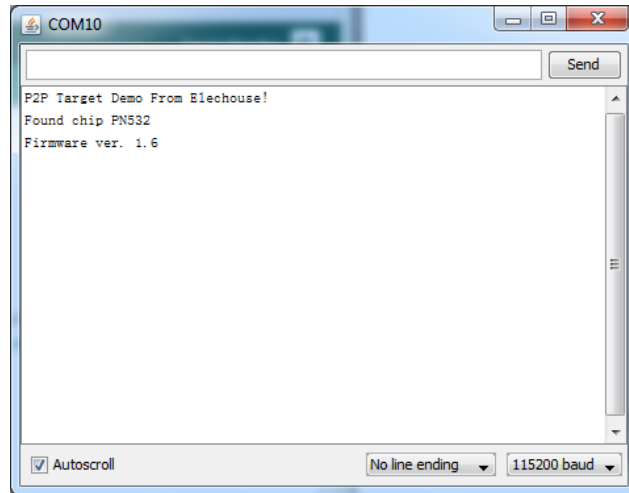

Initiator:

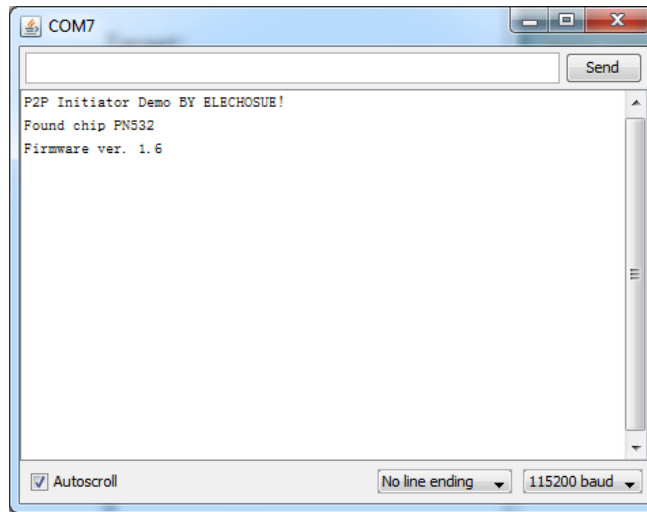

Then put one module above the other:

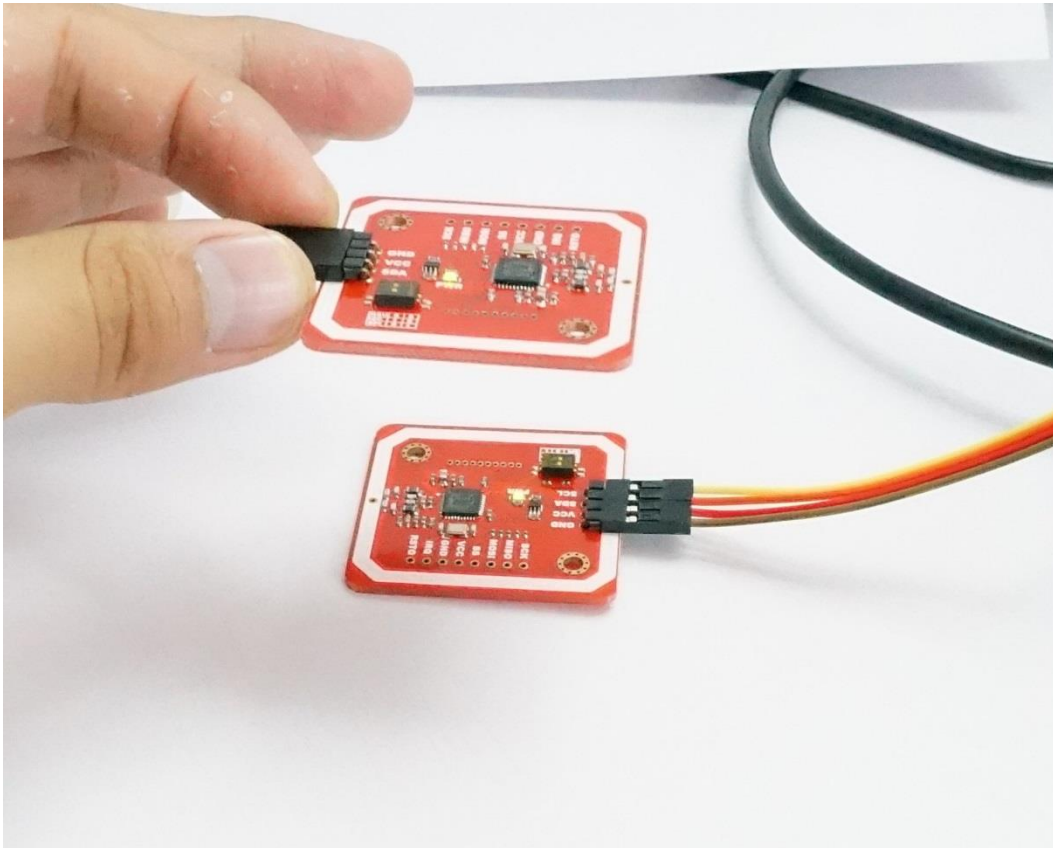

Finally we get:

Target:

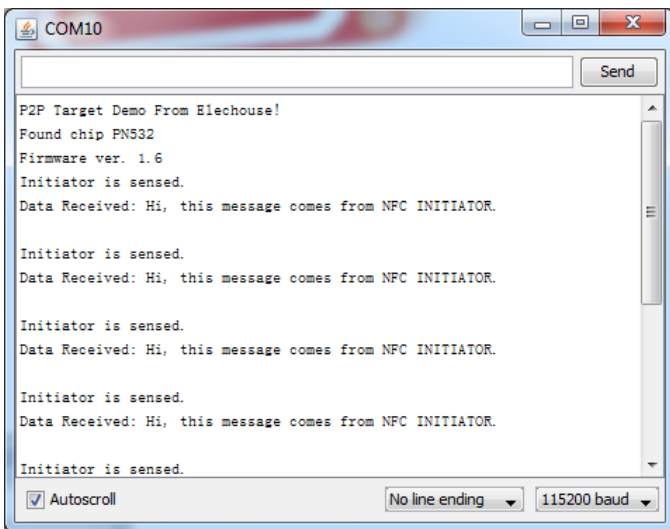

Initiator:

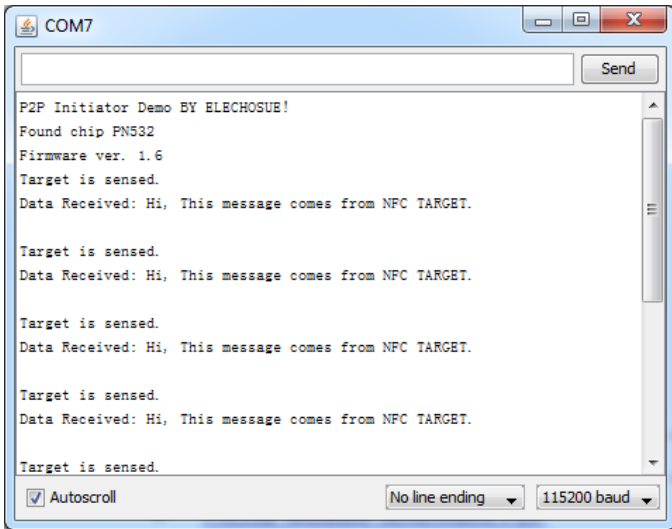

NFC with Android phone

Download the library of [NFC Module DEV](#) from our github page.

Note, while testing this library, please remove the libraries in the testing above (or other PN532 libraries) to other folders. Otherwise they might conflict.

Currently this library only supports HSU mode. We are still working on more modes. If you want to use SPI mode, you could try [NFC Shield DEV](#). Just connect Arduino with our PN532 module through SPI interface in the way shown in the table above.

Open the example in Arduino Due:

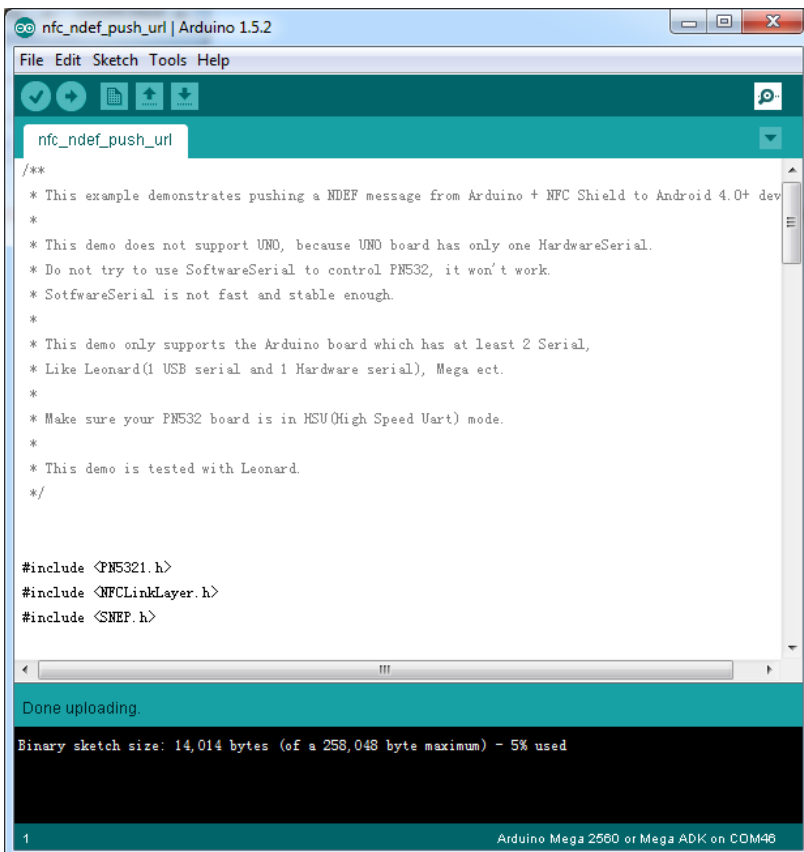

Upload the code to Arduino, and open Serial Monitor:

Put a NFC-support phone on the module (the following phone is Nexus 4):



On Android phone, if you have set the default browser, it will start the browser and visit our website: www.elechouse.com

If it doesn't start the browser, please open the browser and try again. Here we tested HTC one and Google Nexus 4. They all work very well. Different NFC phones might have different NFC ICs. If your phone doesn't work with it, try to google information to check if your phone NFC chip is compatible with PN532.

On Serial Monitor you could get the following result:

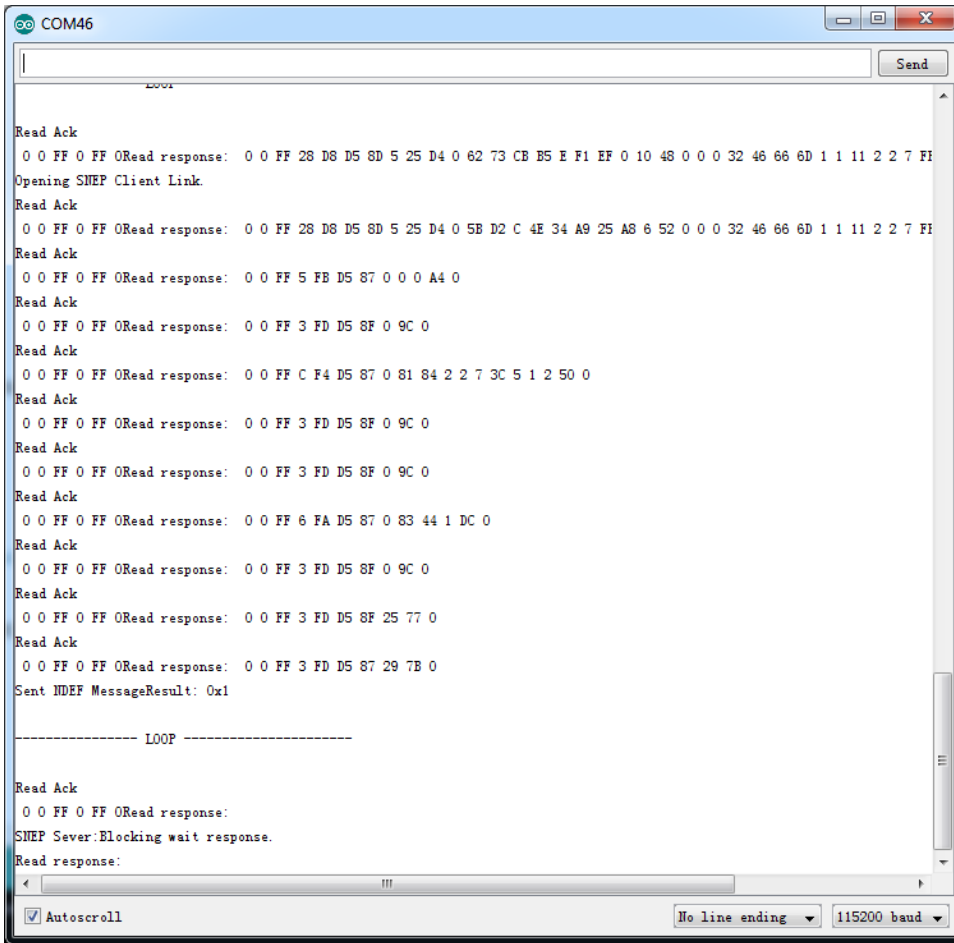

Useful link

- [PN532 Module Schematic PDF](#)
- [NXP PN532 User Manual](#)
- Library: [PN532](#) or [NFC Module DEV](#)

Where to buy

Please visit this page to buy this product: [PN532 NFC module](#)

Disclaimer and Revisions

The information in this document may change without notice. If you have any problem about it, please visit www.elechouse.com to contact us.

Revision History

Rev.	Date	Author	Description
A	Oct. 25 th , 2012	Wilson	Initial version
B	Nov. 5 th , 2013	Wilson	Modify information for V3